

# DUOVAC

## USER MANUAL

Central Vacuum System

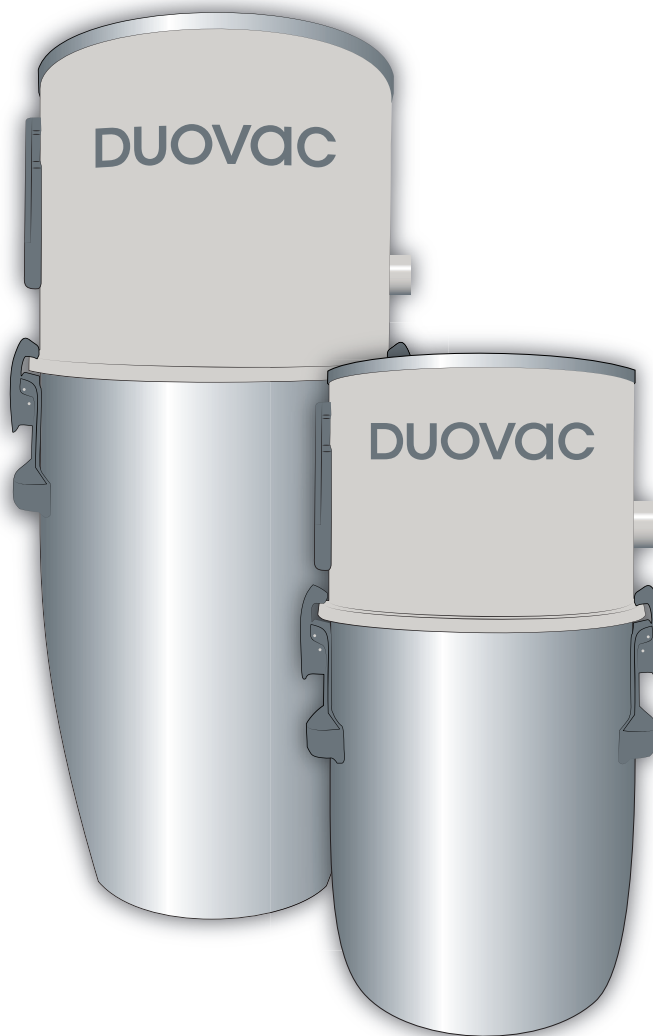

**Intertek**

2000868

Conforms to: UL Std. 1017

Certified to:

CAN/CSA Std. C22.2 No. 243-M91

CAN/CSA Std. C22.2 No. 243-10

DOC-568\_EN REV02

Made in Canada

EN

# TABLE OF CONTENTS

---

<b>IMPORTANT SAFETY INSTRUCTIONS</b> .....	3
<b>GENERAL GUIDELINES &amp; REFERENCE</b> .....	4
<b>GROUNDING REQUIREMENTS</b> .....	4
<b>ELECTRICAL REQUIREMENTS</b> .....	4
GENERAL GUIDELINES TO BE OBSERVED AT ALL TIMES	
<b>MODELS</b> .....	5
<b>INSTALLATION</b> .....	5
<b>POWER UNIT</b> .....	5
<b>MUFFLER</b> .....	6
<b>FLEXIBLE HOSE WITH ERGONOMIC HANDLE</b> .....	6
<b>LOW VOLTAGE WIRE CONNECTION</b> .....	6
<b>SYSTEM OPERATING INSTRUCTIONS</b> .....	6
<b>SYSTEM MAINTENANCE</b> .....	7
<b>FILTRATION SYSTEM</b> .....	7
PERMANENT FILTER; DISPOSABLE FILTRATION BAG	
<b>MOTOR</b> .....	7
<b>HOSE HANDLE</b> .....	7
<b>TROUBLESHOOTING</b> .....	8
<b>LED INTERPRETATION GUIDE</b> .....	8
<b>SERVICE &amp; COMMITMENT</b> .....	9
OUR COMMITMENT: SATISFYING YOUR NEEDS	
<b>RECYCLING INSTRUCTIONS</b> .....	9

# 1. IMPORTANT SAFETY INSTRUCTIONS

## READ ALL INSTRUCTIONS BEFORE USING YOUR CENTRAL VACUUM SYSTEM

When using an electrical appliance, basic precautions should always be followed.

### **WARNING - TO REDUCE THE RISK OF FIRE, ELECTRIC SHOCK OR INJURY:**

- Unplug and disconnect the power unit from the electrical outlet before servicing or maintenance.
- Do not install outdoors and do not use on wet surfaces.
- This appliance can be used by children aged from 8 years and above and persons with reduced physical, sensory or mental capabilities or lack of experience and knowledge if they have been given supervision or instruction concerning use of the appliance in a safe way and understand the hazards involved.
- Children shall not play with the appliance.
- Cleaning and user maintenance shall not be made by children without supervision.
- Use only as described in this manual. Use only manufacturer's recommended accessories.
- Do not use with damaged cord or plug. If appliance is not working as it should, has been dropped, damaged, left outdoors, or dropped into water, return it to a service centre.
- If the supply cord is damaged, it must be replaced by the manufacturer, its service agent or similarly qualified persons in order to avoid a hazard.
- The removal of the plug has to be such that an operator can check from any of the points to which he has access that the plug remains removed (for commercial use models).
- Do not pull or carry by power cord, use cord as a handle, close a door on cord, or pull cord around sharp edges or corners.
- Check inlet openings for small objects that may not have been vacuumed in order to keep openings clear of air flow reducing factors.
- Keep power cord away from heated surfaces.
- Do not unplug by pulling on power cord. To unplug, grasp the plug, not the cord.
- Do not handle system or accessories with wet hands.
- Keep hair, loose clothing, fingers, and all parts of body away from openings and moving parts.
- Turn off all controls before unplugging.
- Use extra care when cleaning on stairs.
- Do not use to pick up flammable or combustible liquids such as gasoline or use in areas where they may be present.
- Connect to a properly grounded outlet only. See grounding requirements in section 2.
- Do not exhaust into a wall, a ceiling or concealed space of a building or structure, use appropriate installation to exhaust outside the residence.
- Make sure that the air exhaust is never obstructed.
- Do not pick up anything that is burning or smoking, such as cigarettes, matches, or hot ashes.
- Do not place or store anything on top or around of the power unit, overheating of motor could occur.

## SAVE THESE INSTRUCTIONS

INTENDED FOR HOUSEHOLD USE ONLY

## 2. GENERAL GUIDELINES & REFERENCE

### GROUNDING REQUIREMENTS

This power unit must be grounded. If it should malfunction or breakdown, grounding provides a path of least resistance for electric current to reduce the risk of electric shock. This power unit has a power cord of 5.4' / 1.65 m in length and is equipped with a grounding conductor and grounding plug. The plug must always be inserted directly into an electrical outlet that is properly installed and grounded in accordance with all local codes and regulations.

#### DO NOT USE AN EXTENSION CORD.



#### WARNING:

**Improper connection of the equipment grounding conductor can result in a risk of electric shock. Check with a qualified electrician or service person if you are in doubt as to whether the outlet is properly grounded. Do not modify the plug provided with the power unit – if it will not fit the outlet, have a proper outlet installed by a qualified electrician.**

**The unit has a grounding attachment plug. Make sure that the power unit is connected to an outlet having the same configuration as the plug. No adapter should be used with this power unit. The power unit should be connected to an independent circuit breaker.**

### ELECTRICAL REQUIREMENTS

The following models are to be used on a nominal circuit of 15 A at 110-120 Volts A.C. and 60 Hz: A10-130-NA-D, A10-260I-NA-ED, SEN-260I-NA-D, STR-190I-NA, SIG-290I-NA, A50-170I-NA, SYM-150I-NA.

The following model is to be used on a nominal circuit of 15 A at 220-240 Volts A.C. and 60 Hz: DIS-200-NA-D.

The following models are to be used on a nominal circuit of 10 A at 220-240 Volts A.C. and 50 Hz: A10-260I-EU/CH/UK/SE-ED, SEN-260I-EU/CH/UK/SE-D, STR-190I-EU/CH-UK/SE-D, SYM-270-EU/CH/UK/SE-D, SIL-280-EU/CH/UK/SE-D.

The following models are to be used on a nominal circuit of 15 A at 220-240 Volts A.C. and 50 Hz: SIG-200-EU/CH/UK/SE-D, DIS-200-EU/CH/UK/SE-D.



#### NOTE

» Other optional suffixes can be used, on all models, to denote cosmetic changes.

### GENERAL GUIDELINES TO BE OBSERVED AT ALL TIMES

1. The power unit must be installed in a ventilated area away from any heat source;
2. The Duovac central vacuum system must be used only on dry surfaces. At no time should the system be used to draw up liquids nor should it be used to vacuum wet carpets or floors.
3. It is mandatory that the filtration cage (as applicable) be equipped with its permanent filter at all times when the system is in use;
4. The motor housing must never be obstructed in any way to avoid overheating or damaging;
5. DO NOT vacuum gypsum dust, flour, mud, or any sludgy materials as they will cake onto the filter and obstruct the filtration system resulting in the over-heating of the motor and thus failure of the power unit to function properly;
6. Do not attempt to shorten or modify the electrical power cord;
7. As a security measure, unplug the electrical power cord before proceeding with any maintenance;
8. In order for the warranty to be valid, only a Duovac authorized service personnel may carry out the necessary repairs or maintenance on the motor;
9. Power unit must be so positioned that the plug is always easily accessible.
10. Pertaining to a 110V/24V valve (intended for the connection of a current-carrying hose/motorized nozzle combination):
  - Connect only a current-carrying hose to this wall valve;
  - Do not install a wall valve outdoors;
  - Do not use with a damaged hose. Return hose to a service centre;



#### IMPORTANT

**Duovac is not responsible for damages resulting from improper use. The warranty does not cover damage resulting from misuse or problems resulting from installation that does not conform to specifications, or any functional alterations and / or physical changes to the power unit. Improper or non-recommended installation of the system and / or power unit done against predefined principles of the user manual is also considered misuse.**

**All conditions and restrictions are set forth in the Duovac limited warranty, the user manual and the system installation guide. To optimize the performance and life of your Duovac power unit, it is important to do regular maintenance and cleaning of the filter according to the guidelines listed in this user manual.**

## 3. MODELS

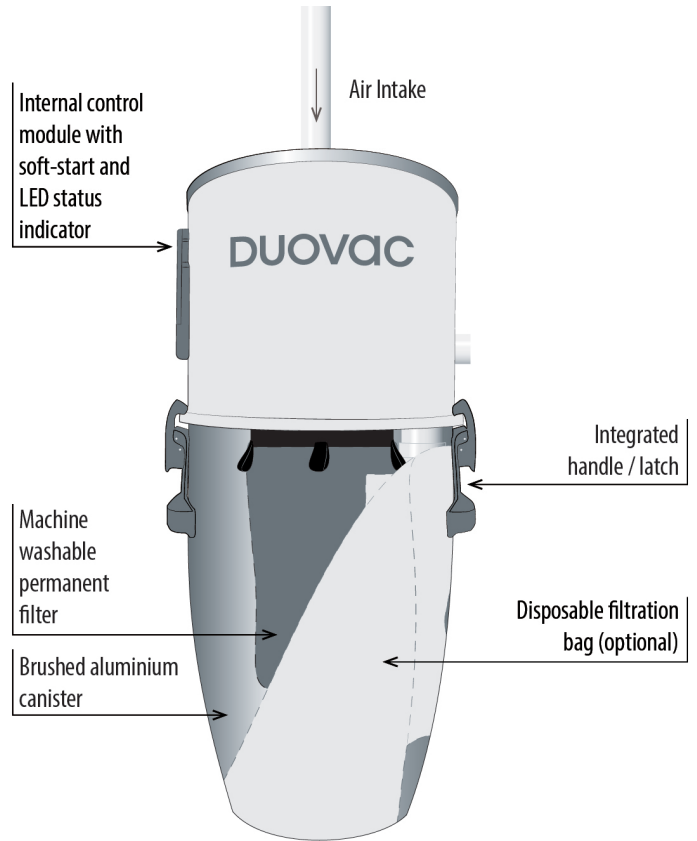
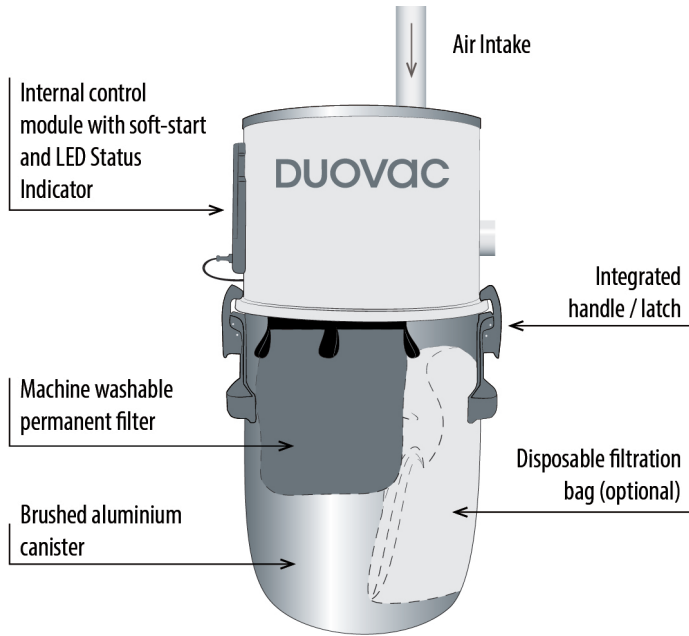

**i NOTE**  
 » APPLICABLE TO ALL POWER UNITS: in order to avoid overheating, we recommend 12in / 30cm clearance all around the power unit.

## 4. INSTALLATION

### POWER UNIT

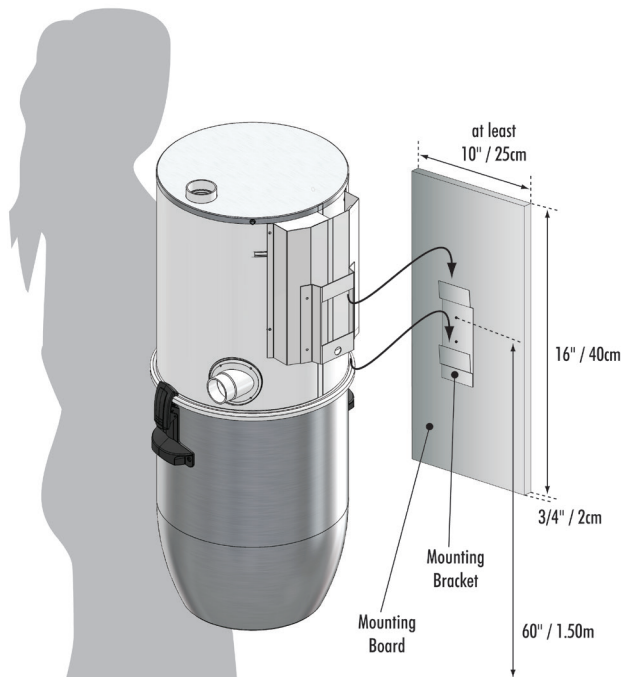

Fig.1 Mounting bracket are the same for all units

The power unit must be installed in a ventilated area, easily accessible and away from any heat source. It should also be close to an accessible electrical outlet.

- Determine the location of the power unit on the wall; we recommend that the power unit be fastened at 60" / 1,5m from the ground in order for the dust canister to be readily accessible; allow 12" / 30cm clearance on all sides of the power unit. When possible, it is advisable to install the power unit on a concrete wall in order to minimize the vibrations;
- Gypsum wall:**
  - Prepare the wall by installing a plywood mounting board (not provided) 16" / 40cm high by 3/4" / 2cm thick and wide enough to be screwed to at least 2 studs;
  - Fasten the mounting bracket to the mounting board with the provided screws;
- Concrete wall:**
  - Drill the holes with a concrete drill bit;
  - Insert the provided wall anchors into the drilled holes;
  - install the mounting bracket with the provided screws into the anchors;

**i NOTE**  
 » You can still install a plywood mounting (16" / 40cm x 10" / 25cm x 3/4" / 2cm) board if desired;  
 » You can use provided screws to fix mounting board on the wall, but cannot use them for installing the mounting bracket on the mounting board because of their length. You need to use shorter screws (not provided).

**! IMPORTANT**  
 Always use the right type of screws for the surface you are working with (wood, concrete, metal...)

- Insert the power unit bracket into the mounting bracket (Fig. 1).
- Insert the PVC pipe into the air intake coupling; **DO NOT GLUE!**

6. Connect the control module (see section 6)
7. Install the muffler (according to model requirement);
8. Connect the power unit directly into an electrical outlet;

## MUFFLER

The purpose of a muffler is to reduce the sound emitted by the system. To install the muffler on your power unit, follow these simple steps:

1. Turn off and unplug the unit;
2. Attach the 90° long elbow upwards or downwards onto the motor exhaust pipe;
3. Secure the muffler onto the 90° long elbow (if the inlet pipe of the muffler is made of PVC, we recommend gluing it in place using a PVC solvent glue);
4. **OPTIONAL** - If you plan on exhausting the vacuum cleaner outside, install more PVC piping starting from the other end of the muffler, gluing the piping in place.

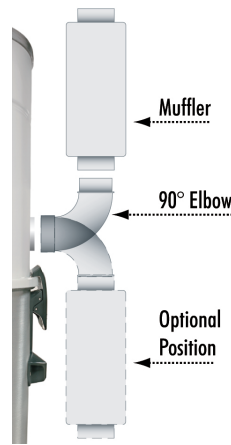

### NOTE

» The muffler can be oriented in the direction of the exterior vent. The 90° elbow is not mandatory.  
 » In case of space restriction around the power unit, install the muffler at any convenient distance using spare piping.

Fig.2 Applicable to some models

## 5. FLEXIBLE HOSE WITH ERGONOMIC HANDLE



Fig.3 Low voltage technology handle

At Duovac, we understand that your cleaning experience with a central vacuum system begins above all with the use of the flexible hose and accessories. This is why we offer products above market standards, on top of having unequalled advantages like the best warranty in the industry.

Your Duovac flexible hose comes with a uniquely designed ergonomic handle, which makes its use pleasant and worry-free.

In your Duovac hose handle, you will find the same quality, durability and solid design made with first quality materials. The top-of-the-line finish of your Duovac flexible hose is perfectly harmonized with a series of accessories chosen by Duovac to make a perfect cleaning kit. The performance, simplicity and durability are the three principles which led to the development of your Duovac accessory kit. We are convinced that your cleaning experience will be improved by it.

## 6. LOW VOLTAGE WIRE CONNECTION

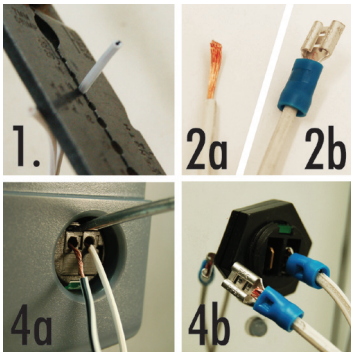

Fig.4 Low voltage wire connection

Before connecting the low voltage wires, make sure that the power unit is disconnected from the electrical outlet.

1. First, strip the low voltage wires approximately 3/8in / 10mm.
2. Refer to Fig. 4 for visual aid:
  - **2a:** The power unit is an EZ connector-type, leave the wires stripped.
  - **2b:** The power unit is a PIN connector-type, you must crimp the connectors onto the wires in order to hook-up the system.

3. Insert the low voltage wires into the power unit's low voltage terminal. Slightly pull on the low voltage wires to verify that they are properly fastened to the terminal.
4. To remove the wires:
  - **4a (EZ connector):** Gently press the tabs above each terminal with a screwdriver and pull the wires out.
  - **4b (PIN connector):** gently pull the connector out of the socket.

## 7. SYSTEM OPERATING INSTRUCTIONS

Your new system is ready to be used, here are some simple guidelines to follow when using your power unit:

- Insert the flexible hose in one of the wall or floor vacuum inlets installed in your home;
- If you use a hose fitted with a remote switch on the handle, use the interrupter on the hose's handle to turn the power unit on/off.

# 8. SYSTEM MAINTENANCE

## FILTRATION SYSTEM

In order to maintain good air quality in your home, the power unit is equipped with a filtration system. It consists of a permanent filter and an optional disposable filtration bag. The filter separates dust from the air. The filters refine the filtration process retaining extra fine dust particles, as minute as 0.1 micron (the diameter of one hair is approximately 60 microns).

### PERMANENT FILTER

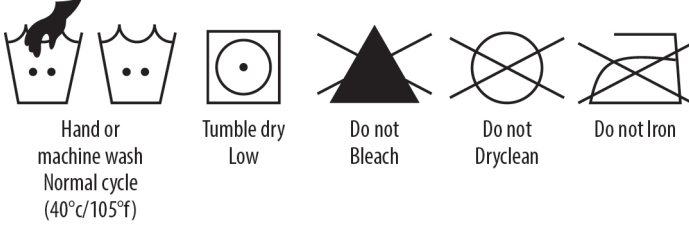

Duovac's filtration system will maintain its high performance as long as it is well looked after. The permanent filter can be machine-washed and tumble dried.



**SILPURE**  
a Thomson Research technology

A natural protection (GREEN) against odor-causing bacteria, SILPURE exploits the natural power of silver in stopping the growth of a wide range of bacteria. It is recommended that the dust canister be emptied every three (3) months or more often depending on the use you make of your system.

### IMPORTANT

**DO NOT vacuum gypsum dust, flour, mud, or any sludgy materials as they cake onto the filter and obstruct the filtration system resulting in the over-heating of the motor and thus failure of the power unit to function properly;**

**If you are not using a disposable filtration bag in addition to the permanent filter, empty the dust canister regularly to ensure a longer lasting life of the motor.**

**If you are using the disposable filtration bag, it should be checked / changed as often as you would empty the dust canister.**

While emptying the power unit's dust canister, the permanent filter should also be cleaned:

1. Unlatch the dust canister;
2. Wrap a plastic / paper bag around the filter and gently pat the filter to dislodge any loose dust into the bag.
3. Empty the dust canister into a garbage bag.

### NOTE

» We recommend that the permanent filter be deep-cleaned once a year;

a. **Remove the dust from the filter by gently patting it into a bag as mentioned above;**

b. **Remove the filter by pulling it down;**

c. **Drop it into the washer.**

d. **Set the washer to a normal wash cycle (warm or cold water) then, spin dry (regular cycle) for 10 minutes;**

e. **Before replacing the filter, clean the inside of the filtration cage;**

### IMPORTANT

**Do not turn filter inside out. It must be replaced over the cage on the same fabric side as initially mounted in the factory.**

**It is very important that the filter be slipped over the metal rim located at the top of the cage. In order to prevent any dust infiltration into the motor, the cage must be completely covered by the filter;**

f. **Clip the dust canister back onto the casing.**

## DISPOSABLE FILTRATION BAG

In order to maximize your system's filtration capabilities, all Duovac power units (except the SIG-200) come with a disposable filtration bag. See below instructions on replacing the disposable filtration bag depending on the system being used:

DISPOSABLE FILTRATION BAG	VACUUM MODEL
FILTRE-189	A10-130I
	A10-260I(-NA/-EU/-CH/-UK/-CN)-ED
FILTRE-196	A10-260I(-NAEDSN/-NAEDSO)
	A50
	DIS
	SEN
	SIL
	STR
	SYM

The disposable filtration bag must be changed at least every 3 months to ensure proper functioning of the power unit.

To change the filtration bag, please proceed as follows:

1. Unlatch the dust canister;
2. Remove the disposable bag from the elbow attachment by gently pulling on both sides of the cardboard cuff;
3. Dispose of the used bag;
4. Slip the new disposable filtration bag onto the elbow fixture by gently pressing on both sides of the cardboard cuff until it reaches the stop notch on the elbow.

## MOTOR

All units are equipped with a soft-start control module and have a LED communicating the system status (see fig. 5 in section 9 for more details on LED color interpretation). When the LED changes to amber, it is time to make an appointment with a Duovac certified technician for a complete check-up of the unit. This mandatory maintenance will extend the life of the unit and keep the warranty valid. If it is still not carried out after 20 hours of additional operating, the device will automatically switch off as a safety measure.

All systems also have a mini breaker (power cut-off) directly connected to the module which protects the motor against an overload and prevents overheating.

## HOSE HANDLE



Wipe the hose handle regularly with a moist towel to avoid buildup.







# 9. TROUBLESHOOTING

Failure of the power unit could be caused by:

- Inadequate power level (voltage / amperage) (ensure that power level complies with the power unit's electrical requirements);
- Malfunction of the motor or control module.

Simple checks can often help you find out why your power unit is inoperative. We invite you to verify the following before calling a service technician.

SITUATION	VERIFICATION
NO POWER	Check that the power unit's electrical cord is plugged directly into a power outlet;
	The power unit is equipped with a mini breaker (button on the side of the motor housing) which protects the motor against an overload. To reset the mini breaker, simply push the button. If the power goes off one more time, call a service centre near you;
	Using a screwdriver fitted with a rubber handle, touch both pins of the low voltage terminals (short circuit the 2 pins) on the side of the motor housing. If the power unit starts, the problem lies with the low voltage wiring (installed along the piping).
	You should then verify if the 24 Volts circuit is adequately connected by checking each inlet. Open the inlet cover, touch the small contacts with the head of a pair of metal pliers with rubber handles. This will establish power and start the motor. Repeat for each vacuum inlet;
	 <b>NOTE</b> » If all vacuum inlets are functional and your flexible hose is a low voltage technology handle, then there may be a defect in the cut-off switch of the hose or the hose itself;
	Check the breaker on your electric circuit panel;
DECREASED SUCTION	The flexible hose may be blocked. If you cannot unblock it, try inserting the opposite end of the hose into the wall inlet; touch the contacts which are located on the inside of the inlet with the hose wand in order to start the power unit;
	 <b>NOTE</b> » Frame the inlet with your hands or a large enough piece of cloth (such as a towel) to ensure the maximum suction to unblock the hose;
	Check whether the dust canister / disposable filtration bag / permanent filter needs to be emptied / cleaned;
	Check that the canister is clipped properly to the motor housing and that the gasket, which fits around it, is in good condition;
	Make sure all inlets are airtight.
	If the pipes are visible in certain areas: check if the fittings are well glued and that there are no air leaks;
	If the pipes should be blocked behind the walls, it is possible to determine where the blockage is located by starting from the furthest inlet from the central vacuum. Insert a tissue paper and check to see if the tissue paper reaches the dust canister. Repeat the same for each inlet.

Level	LED on Power Unit	Meaning
0		The power cord is not connected to an electrical outlet.
1		The power unit has just been connected. Will change to level 2 after a few seconds.
2		The system is operational.
3		Stop power unit then empty dust container (or change bag) if needed (automatic reminder after 15hrs). Hold reset button pressed 5s then the light will stop blinking.
4		Stop power unit then empty dust container (or change bag). Remove and clean the filter. No reset is required. Power unit will return to level 2.
5		Inspection is required.
6		Stop and service power unit.

 Solid

 Blinks Slow

 Blinks Fast

## LED INTERPRETATION GUIDE

All Duovac power units with internal control module come with an explicative sticker (inside the module casing cover where applicable).



### NOTE

» The indicator in step 4 will only appear on A50 power units.

Fig.5 LED interpretation guide



# 10. SERVICE & COMMITMENT

---

## OUR COMMITMENT: SATISFYING YOUR NEEDS

In an effort to always provide the customers with the best products available we welcome comments and suggestions from our customers all over the world. We want to develop a strong commitment in providing all of our customers the products which are always of the finest quality that meets or exceeds their needs.

So, if you have any comments or suggestions related to our products or distributors, please contact us.

For any inquiries:

**E-mail us at:**

**info@duovac.com**

**Send us your comments to :**

Nuera Air Inc. - Customer Service  
1490 DAGENAIS BLVD WEST  
LAVAL (QC) H7L 5C7 CANADA

**Contact your local distributor:**

Distributor's coordinates

Attach distributor's business card for convenient reference

**You can also visit our website  
to see all our products or find a  
local distributor:**

**www.duovac.com**

# 11. RECYCLING INSTRUCTIONS

---

Old power units contain valuable materials that can be recycled.

**DO NOT** dispose of such appliances with the normal domestic waste but rather by way of appropriate collecting points.

# DUOVAC

# DUOVOC

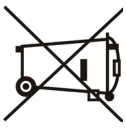

**UK**

## Recycling Instructions

Old appliances contain valuable materials that can be recycled. **DO NOT** dispose of such appliances with the normal domestic waste but rather by way of appropriate collecting points.

**FR**

## Instructions de recyclage

Les vieux appareils contiennent les matériaux importants qui peuvent être réutilisés. Ne vous débarrassez pas de tels appareils avec le débarras domestique normal mais plutôt par les centres de rassemblement appropriés.

**ES**

## Instrucciones de Reciclaje

Los viejos aparatos contienen los materiales importantes que pueden reutilizarse. No quita tales aparatos con el trastero doméstico normal sino más bien por los centros de reunión convenientes.

**DE**

## Recycling Hinweise

Die alten Geräte beinhalten wiederverwendbare Materialien. Werfen Sie die Geräte nicht in den Hausmüll, sondern entsorgen Sie diese an geeigneten Sammelstellen.

**SE**

## Återvinning

En centraldammsugare består av material och komponenter som kan återvinnas. Använd därför alltid lämplig sorteringsmetod eller återvinningscentral.

**CZ**

## Recycling Pokyny

Staré přístroje obsahují cenné materiály, které jsou vhodné k opětovnému zpracování. Přístroj neodkládejte k běžnému domácímu odpadu, nýbrž nechat zlikvidovat prostřednictvím vhodných sběrných systémů.

**IT**

## Istruzioni di Riciclaggio

I vecchi apparecchi contengono i materiali importanti che possono essere riutilizzati. Debarrassez tali apparecchi con il sgabuzzino domestico normale ma piuttosto con i centri di raccolta adeguati.

**CN**

## 回收说明

老设备包含一些可以回收的有用材料。请勿将这样的设备与普通的生活垃圾一起处理，而是通过适当的收集站处理。

**SA**

## تعليمات متعددة اللغات لإعادة التدوير

تحتوي الأجهزة القديمة على مواد قيمة صالحة لإعادة التدوير. لا تطلق بالجهل مع النفايات المنزلية، بل قم بالتخلص منه على النحو المطلوب من خلال نقاط الجمع الملائمة.

**PL**

## Rekolaryskie Polecenia

Zużyte urządzenia zawierają wartościowe materiały, które nadają się do powtórnego przerobu. Urządzenia nie wyrzucać z odpadami domowymi, lecz należy je oddać w odpowiednim punkcie zbiórki surowców wtórnych.

**PT**

## Instruções Recicladoras

Aparelhos usados contém materiais valiosos, que são aproveitados para reprocessamento. Não colocar o aparelho no lixo doméstico normal, mas sim descartar correctamente através dos sistemas de colecta adequados.

**HU**

## Újrahasznosításra

A használt készülékek értékes anyagokat tartalmaznak, melyek újrahasznosításra alkalmasak. A készüléket ne tegyük háztartási szeméttbe, hanem megfelelő gyűjtőrendszerrel igénybevételeivel szakszerűen ártalmatlanítsuk.

**GR**

## Οδηγίες της ανακύκλωσης

Οι παλιές συσκευές περιέχουν τα σημαντικά υλικά που μπορούν να ανακυκλωθούν. Δεν αναλόγωςτε τέτοιες συσκευές με τις εσωτερικές φύδες αλλά μάλλον από τα κατάλληλα κέντρα της συσκευών.

**DK**

## Genanvendelse Instruks

Gamle apparater indeholder værdifulde materialer der er egnet til genbrug. Bortkaf ikke apparatet via det normale husholdningsaffald, men fagmæssigt korrekt via egnede samlesystemer